

VF35.550
PGVF35.550
(schaal 1 : 4)

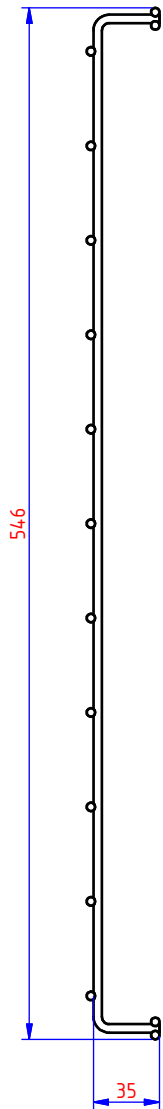

VF35.450
PGVF35.450
(schaal 1 : 4)

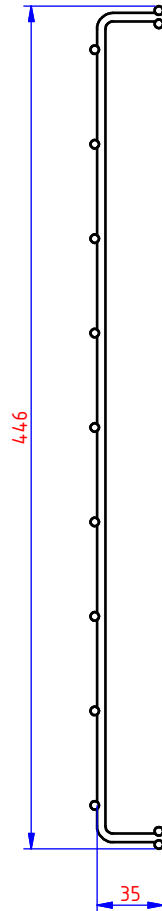

VF35.350
PGVF35.350
(schaal 1 : 4)

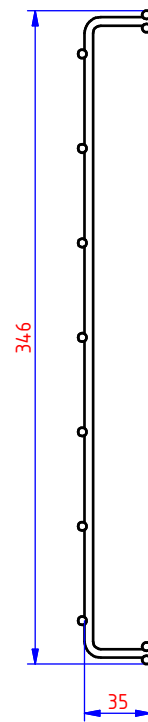

VF35.250
PGVF35.250
(schaal 1 : 2)

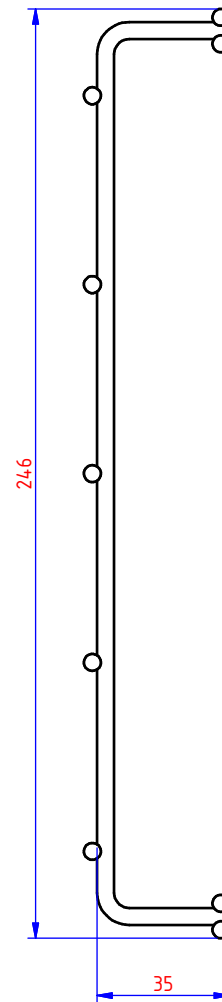

VF35.200
PGVF35.200
(schaal 1 : 2)

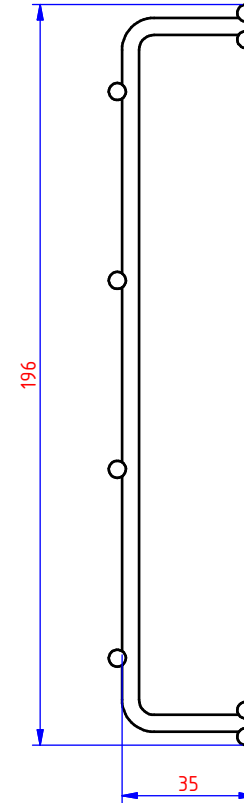

VF35.150
PGVF35.150
(schaal 1 : 2)

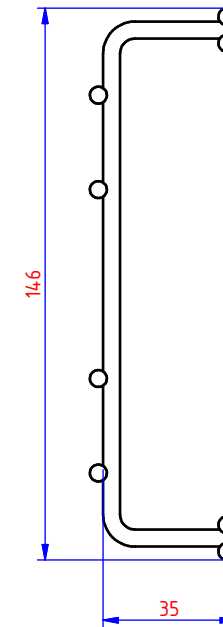

VF35.100
PGVF35.100
(schaal 1 : 2)

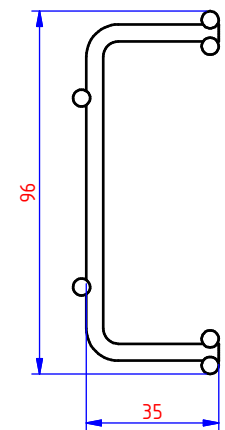

lengte goot: 3004 mm
dwarsdraden om de 100 mm
draaddiameter: Ø4.5mm
NOT FOR PRODUCTION

| Number | Edition | Description of the modification | Date | By |
|--------|---------|---|----------|----|
| 3 | A | Dubbele langsdraad bovenaan | 12/11/01 | |
| | B | positie langsdraden (geen op 25 mm van de dubbele draad) | 12/11/01 | |
| | C | afronden breedtemaat gestrekte net (uniformiteit tekeningen) (ED) | 08/08/11 | |

| | | | | |
|----------------------|------------|-----------|--|--|
| Ref. | VF----- | Name | Wire cable tray for heavy duty [VF35.100] | |
| Drawn | delombel | | | |
| Date | 7/01/1998 | | | |
| Material: | Tolerance: | Standard: | I.S.O. SYMBOL | |
| 1.0037 (Zinc plated) | - | IEC 61537 | | |

| | | | | | |
|---|--|--|------------------------------------|-------|-------|
| | | Scale: | Adapt drawing exclusively with CAD | FORM | P. 24 |
| | | - | | | |
| Meersbloem Melden 16 9700 Oudenaarde | | Tel: 055/31.83.35 Fax: 055/31.43.88 | | 44011 | |

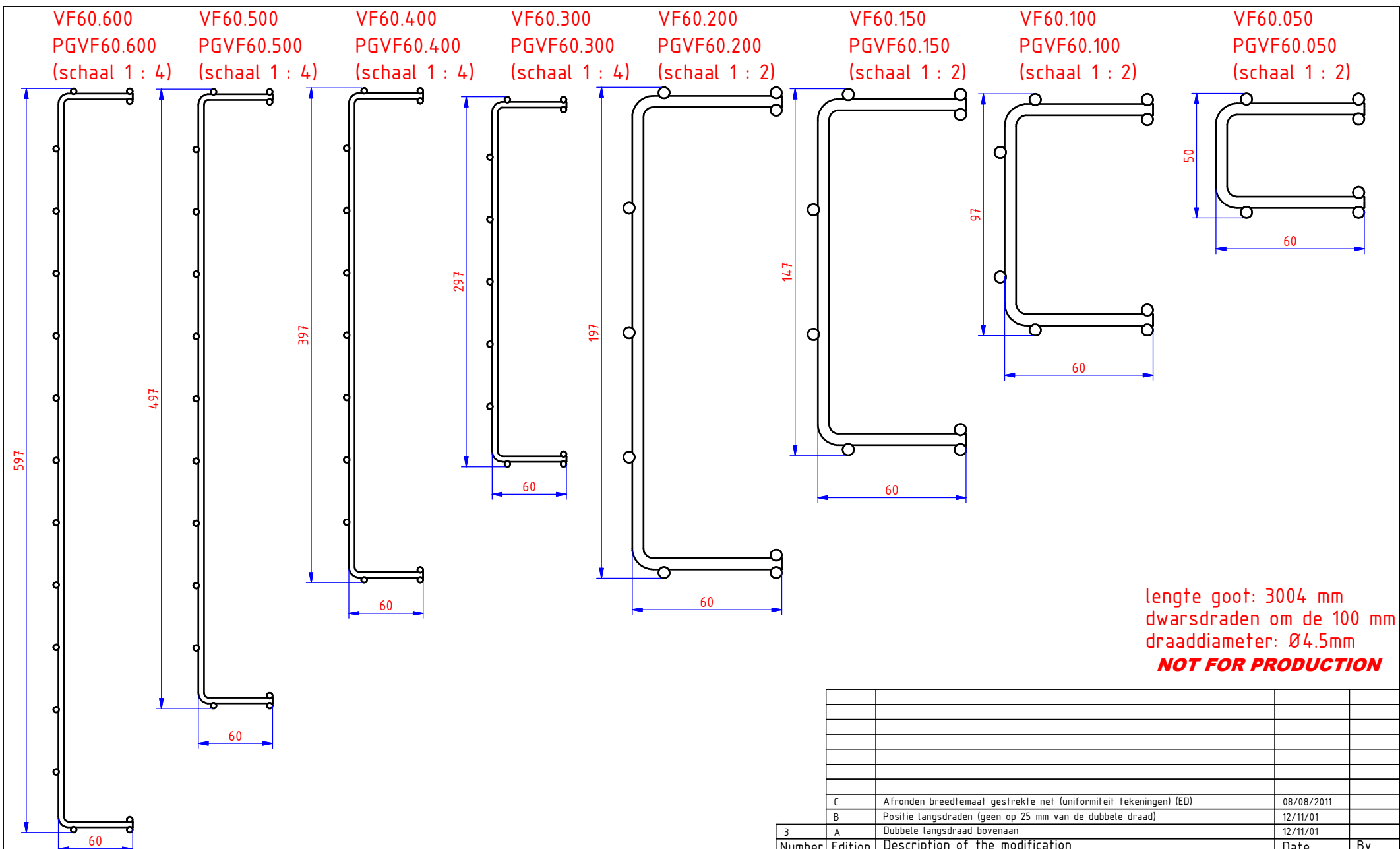

lengte goot: 3004 mm
 dwarsdraden om de 100 mm
 draaddiameter: Ø4.5mm
NOT FOR PRODUCTION

| Number | Edition | Description of the modification | Date | By |
|--------|---------|---|------------|----|
| 3 | A | Dubbele langsdraad bovenaan | 12/11/01 | |
| | B | Positie langsdraden (geen op 25 mm van de dubbele draad) | 12/11/01 | |
| | C | Afronden breedtemaat gestrekte net (uniformiteit tekeningen) (ED) | 08/08/2011 | |
| | | | | |
| | | | | |
| | | | | |
| | | | | |
| | | | | |
| | | | | |
| | | | | |

| | | | |
|----------------------|------------|-----------|--------------------------------|
| Ref. | VF----- | Name | Wire cable tray for heavy duty |
| Drawn | delombel | | [VF60.050] |
| Date | 7/01/1998 | | |
| Material: | Tolerance: | Standard: | I.S.O. SYMBOL |
| 1.0037 (Zinc plated) | - | IEC 61537 | |

VERGOKAN

Meersbloem Melden 16
9700 Oudenaarde

Tel: 055/31.83.35
Fax: 055/31.43.88

Scale: -

Adapt drawing exclusively with CAD

DRAWING NUMBER: 44011

FORM A4

P. 25 / 31 P.

VF85.450
PGVF85.450
(schaal 1 : 4)

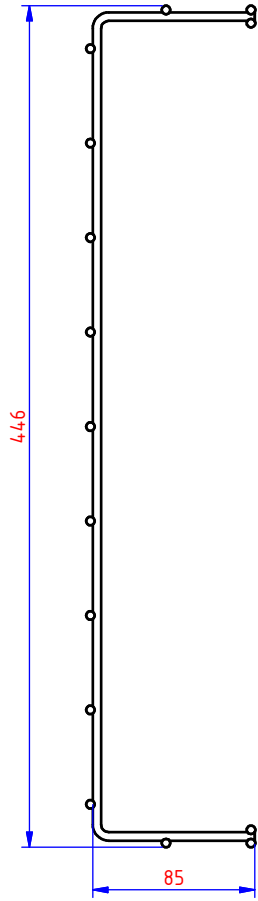

VF85.350
PGVF85.350
(schaal 1 : 4)

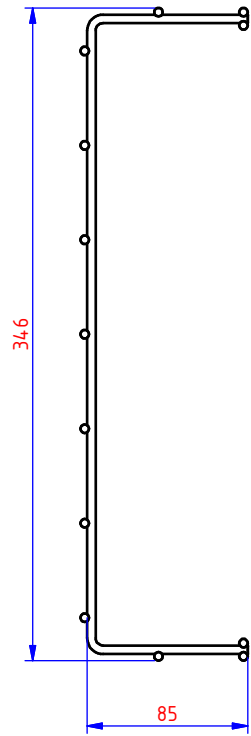

VF85.250
PGVF85.250
(schaal 1 : 4)

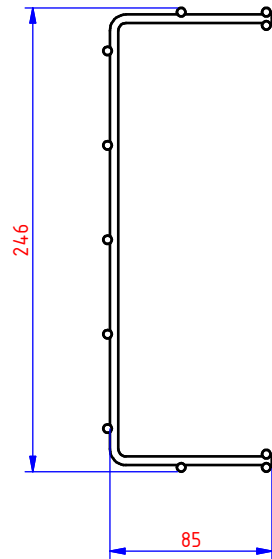

VF85.150
PGVF85.150
(schaal 1 : 2)

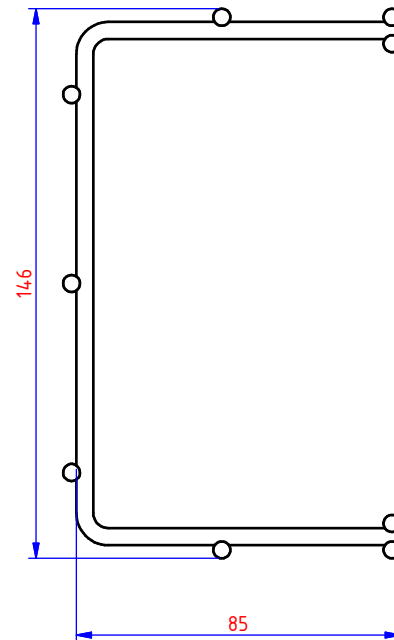

VF85.100
PGVF85.100
(schaal 1 : 2)

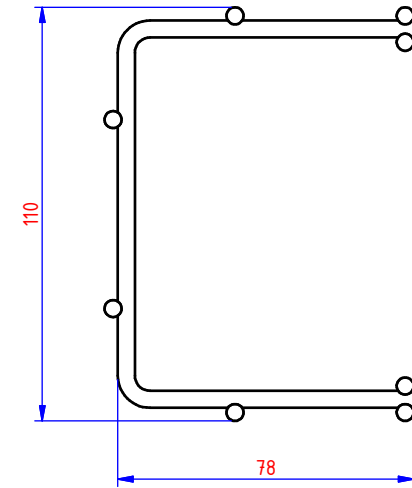

lengte goot: 3004 mm
dwarsdraden om de 100 mm
draaddiameter: Ø4.5mm
NOT FOR PRODUCTION

| | | | |
|--------|---|---------------------------------|---------|
| | | | |
| | | | |
| | | | |
| | | | |
| | | | |
| | | | |
| | | | |
| | | | |
| C | Afronden breedtemaat gestrekte net (uniformiteit tekeningen) (ED) | 08/08/2011 | |
| B | Positie langsdrazen (geen op 25mm van dubbele draad) | 12/11/2001 | |
| A | Dubbele langsdraad bovenaan | 12/11/2001 | |
| 3 | | | |
| Number | Edition | Description of the modification | Date By |

| | | | |
|----------------------|------------|-----------|--------------------------------|
| Ref. | VF---- | Name | Wire cable tray for heavy duty |
| Drawn | delombel | | [VF85.100] |
| Date | 7/01/1998 | | |
| Material: | Tolerance: | Standard: | I.S.O. SYMBOL |
| 1.0037 (Zinc plated) | - | IEC 61537 | |

VERGOKAN

Meersbloem Melden 16 Tel: 055/31.83.35
9700 Oudenaarde Fax: 055/31.43.88

Scale: - Adapt drawing exclusively with CAD

DRAWING NUMBER: 44011 FORM: A4

P. 26 / 31 P.

VF110.400
PGVF110.400
(schaal 1 : 4)

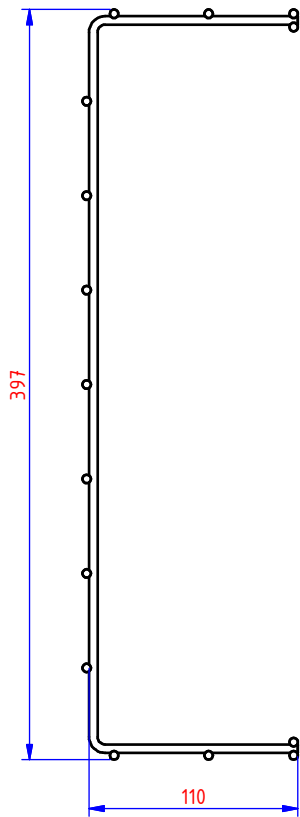

VF110.300
PGVF110.300
(schaal 1 : 4)

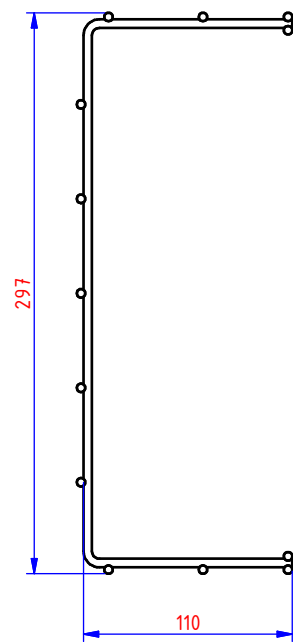

VF110.200
PGVF110.200
(schaal 1 : 2)

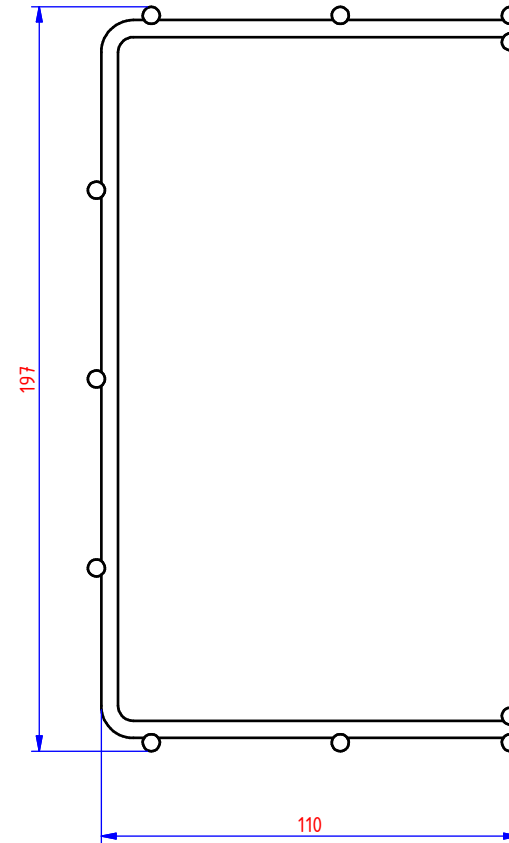

lengte goot: 3004 mm
dwarsdraden om de 100 mm
draaddiameter: Ø4.5mm
NOT FOR PRODUCTION

| Number | Edition | Description of the modification | Date | By |
|--------|---------|---|------------|----|
| 3 | A | Dubbele langsdraad bovenaan | 12/11/01 | |
| | B | Positie langsdraden (geen op 25 mm van de dubbele draad) | 12/11/01 | |
| | C | Afronden breedtemaat gestrekte net (uniformiteit tekeningen) (ED) | 08/08/2011 | |

| | | | | |
|----------------------|------------|-----------|---|--|
| Ref. | VF---- | Name | Wire cable tray for heavy duty [VF110.200] | |
| Drawn | delombel | | | |
| Date | 7/01/1998 | | | |
| Material: | Tolerance: | Standard: | I.S.O. SYMBOL | |
| 1.0037 (Zinc plated) | - | IEC 61537 | | |

| | | | | | |
|---|--|--|------------------------------------|-------|-------|
| VERGOKAN | | Scale: | Adapt drawing exclusively with CAD | | DRAAD |
| Meersbloem Melden 16 9700 Oudenaarde | | Tel: 055/31.83.35 Fax: 055/31.43.88 | - | | |
| | | DRAWING NUMBER | FORM | P. 27 | |
| | | 44011 | A4 | 31 P. | |