

P2097SS
Fitting angle 60° 2D14

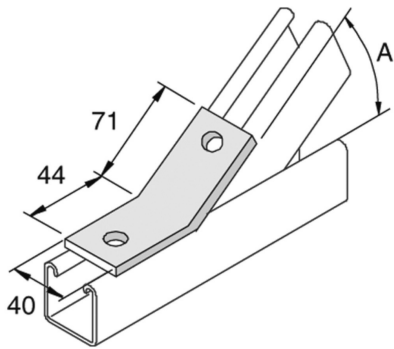

Standard finish

Stainless Steel 316

HD	Reference	↕ mm	↔ mm	↔ mm	↔ mm	kg/stk	📦	Stock	Unit
-	P2097SS		40			0,194	10		STK

To order per full packaging.