

P1038
Fitting 90° angle Lb 3D14

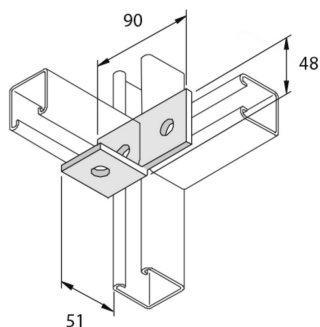

Standard finish		Hot-dip galvanised							
HD	Reference	↕ mm	↔ mm	↔ mm	↔ mm	kg/stk	📦	Stock	Unit
-	P1038	51	48		90	0,317	10		STK

To order per full packaging.

Abbreviation:

- HG = Hot-Dip Galvanised