

P1458

Fitting 90° angle L 3D14

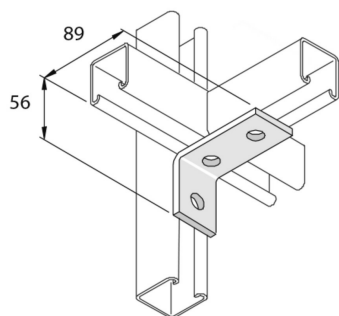

Standard finish		Hot-dip galvanised							
HD	Reference	↕ mm	↔ mm	→ ← mm	↔ mm	kg/stk	📦	Stock	Unit
-	P1458	56	40		89	0,213	10	X	STK

To order per full packaging.

Abbreviation:

- HG = Hot-Dip Galvanised