

P2101
Fitting angle 30° 2D14

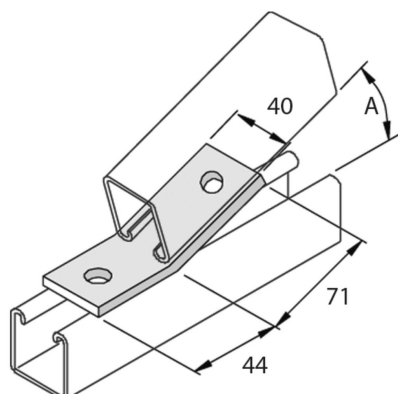

Standard finish		Hot-dip galvanised							
HD	Reference	↕ mm	↔ mm	↔ mm	↔ mm	kg/stk	📦	Stock	Unit
-	P2101					0,188	10		STK

A = 30°

To order per full packaging.

Abbreviation:

- HG = Hot-Dip Galvanised