

P2108

Fitting angle 120° 2D14

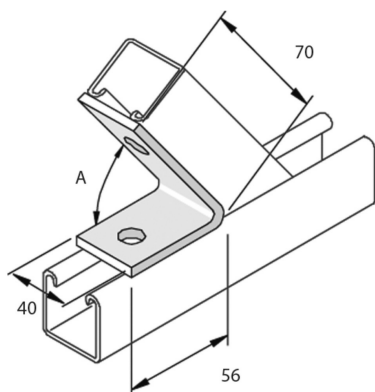

Standard finish		Hot-dip galvanised							
HD	Reference	↕ mm	↔ mm	↔ mm	↔ mm	kg/stk	📦	Stock	Unit
-	P2108					0,188	20		STK

A = 60°

To order per full packaging.

Abbreviation:

- HG = Hot-Dip Galvanised