

**P2095SS**  
Fitting angle 75° 2D14

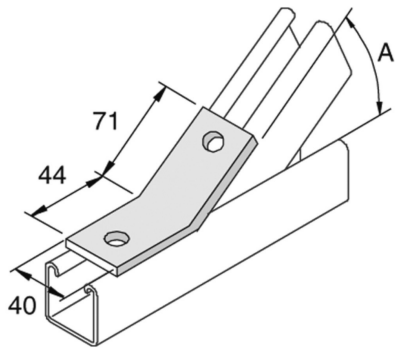

Reference	↕ mm	↔ mm	→  ← mm	↔ mm	kg/stk	📦	Unit
<b>P2095SS</b>		40			0,194	10	STK