

# P1458

## Verbindingsstuk hoek 90° L 3D14

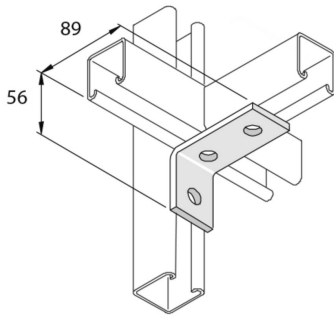

Artikel	Afwerking	↕ mm	↔ mm	→  ← mm	↔ mm	kg/stk	📦	Eenh.
<b>P1458</b>	HG	56	40		89	0,213	10	STK

Afkorting:

- HG = Hot-Dip Gegalvaniseerd

**Legende afwerking**

- HG = Thermisch verzinkt