

P5000T Montageprofiel

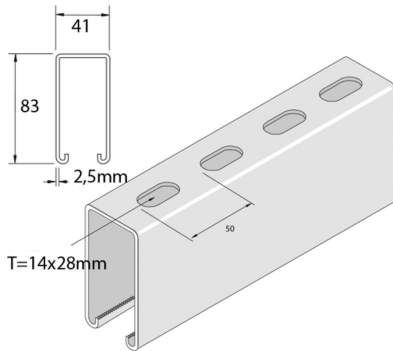

Artikel	Afwerking	↕ mm	↔ mm	→ ← mm	↔↔ mm	kg/m	📦	Eenh.
P5000T	ZP	83	41	2,5	6000	3,926	6	M
P5000TX3	-	83	41	2,5	3000	3,926	60	M
P5000TH	HG	83	41	2,5	6000	4,050	6	M

Afkorting:

- PO = Onbehandeld
- ZP = Verzinkt
- HG = Hot-Dip Gegalvaniseerd

Legende afwerking

- ZP = Elektrolytisch verzinkt
- HG = Thermisch verzinkt